

# Data Logger

---

## User manual



## User Manual

User Cyber-DLog series\_MG  
ISO9001:2015

Subject to change without notice!

# Contents

1. Product safety instructions.....	1
2. Technical parameters.....	2
3. Product overview.....	3
4. Product appearance.....	5
5. Optional and standard accessories.....	6
6. Product dimensions.....	6
7. Installation Instructions.....	7
8. User interface description.....	8
9. System parameter interface.....	11
10. Fault information.....	14
11. System application scheme.....	15

# 1.Product safety instructions

- Thank you for choosing our data logging device. Please read the instructions carefully before using the product.
- Please keep this user manual for future reference.
- When receiving the product, please check whether the goods are damaged during transportation. If any problem is found, please contact our company immediately.
- Please read all instructions and precautions contained in this manual before installation to ensure that the product can work properly.
- Do not expose this product to rain, dust, vibration, any corrosion agents or strong electromagnetic sources.
- Do not open the housing of this product for any maintenace inside.

## 2. Technical Parameters

Model	DLog-1
Applicable products	Lumiax solar controller and inverters with Rs485 port
Input	5Vdc (USB type C) (8 ~ 65Vdc communication interface power supply)
LCD backlight	Yes
Battery type	CR1220, not included
Working environment	-20°C ~ +65°C
Storing environment	-20°C ~ +80°C
Dimensions	112,5*63*23mm
Net weight	0,22kg

### 3. Product overview

DLog-1 is a data logging unit that can be connected to the solar charge controller to display and store the operating values. The display unit is simple in appearance and operation. The LCD screen displays system parameters and various fault alarm information in real time for monitoring the operation status of the a complete system.

Characteristics:

- LCD screen, real-time display of the current system time, as well as PV, battery, load related parameters of the controller.
- Built in 1GB memory card/socket, which can automatically save the collected operating data of the connected controller.
- Automatically read the information of the connected solar controller and store it in the memory. The logging period can be set as required.
- The ID code identifying each solar controller is unique, and a folder named by the ID code will be automatically created on the memory card.

- The first time the Data Logger is switched on, the display will

automatically synchronize to the connected charge controller, considering a 12:00 hour day, being the recording time continuously updated.

- Button type cell battery is installed in the Data Logger; Any possible system power failure will not affect Data Logger actual recording time.
- Fault code display. Can be checked by pressing the key to display any fault or alarm information.
- Communications physical interface: Dual RJ12 type connectors.

## 4. Product Outline

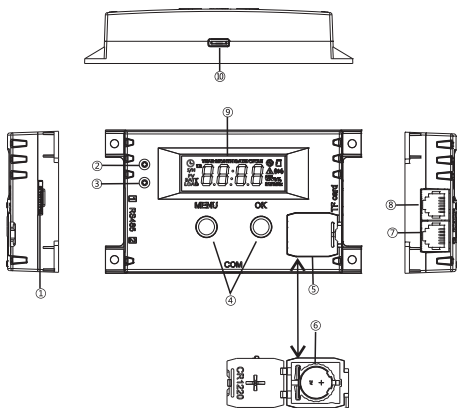

①	Slot (micro SD/TF memory card)	⑥	Battery (CR1220)
②	Green LED indicator	⑦	RS485 communication interface 1 (RJ12)
③	Red LED indicator	⑧	RS485 communication interface 2 (RJ12)
④	Keys	⑨	LCD display
⑤	Battery holder	⑩	C-Type USB connector

## 5. Standard and optional accessories

Classification	Name	Quantity or model	Purpose
Standard accessories	RS485 communication	1	RJ12 interface to the controller
	Storage card	1	Storage data (1GB) *
	card reader	1	Read data
Optional	C-Type USB	1	Connect to PC
	Battery(CR1220)	1	For keeping real time

**Note: if data is stored once every minute, 1GB memory card can store information for 18 years.**

## 6. Product size

Unit : mm

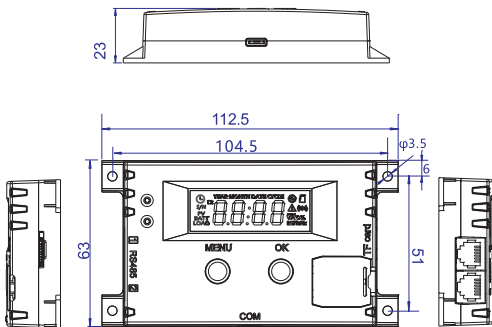



## 7. Installation Instructions

Before installation, please mind that the Data Logger is a non waterproof device.

For affixing the device, please mark 4 mounting holes on the mounting surface and attach it with the 4 screws.

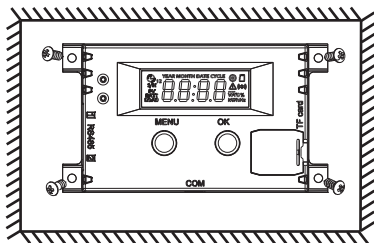

## 8. User interface description

### 8.1 LCD display



Item	Icon/Display	Indication/Current value
Equipment parameters	<b>YEAR</b> 2022	Current year (settable)
	<b>MONTH DATE</b> 7.28	Current month and date (settable)
	<b>⌚</b> 18:22	Current time (settable)
Storage card		Micro SD/TF Card (icon flashes twice while storing data)
Data storage cycle* <sup>1</sup>	<b>CYCLE</b> 5	Data storage interval (settable)
ID code 1* <sup>2</sup>	<b>S/N</b> <sup>1</sup> 3233	Equipment identification code 1 (i.e. the first 4 digits of equipment ID)
ID code 2	<b>S/N</b> <sup>2</sup> 6411	Equipment identification code 2 (the last 4 digits of the equipment ID)
System parameters	<b>PV</b> 8.8 <sup>A</sup>	PV current
	<b>PV</b> 87.6 <sup>V</sup>	PV voltage
	<b>BATT</b> 26.9 <sup>V</sup>	Battery voltage
	<b>BATT</b> 19.8 <sup>A</sup>	Battery current

Item	Icon/Display	Indication/Current value
System parameters		Battery temperature
		Load voltage
		Load current
set up		To adjust the parameters
Error		Fault indication
Parameter		Voltage unit, Volts
		Current unit, Ampere
		Temperature unit, Celsius

Note: Some of the displayed units/iconshave currently no application

\*1: Adjustable setting: 1 ~ 30 minutes (default: save every five minutes)

\*2: The internal folder name of the microSD/TF card is consistent with the ID code of the Data Logger.

The device ID code is 32336411



## 8.2 Key functions and mode settings



Pattern	Operation
Browse mode	Briefly press OK to browse among the various parameters
Static mode	Press the MENU key and the OK key simultaneously to enter the static mode, that is, the current content will than be displayed statically. To exit, press MENU and OK simultaneously to return "interface".

Pattern	Operation
Setting mode	While browsing among the parameters,  press and hold the MENU key to enter the setting mode, and press the MENU key to decrease the setting value, press OK to increase the setting value, and long press MENU to exit the setting; Else, the system will automatically exit after 30 seconds

### 8.3 LED Indicators

LED Indicators	Colour	State	Explain
	Green	On	Normal power
		Off	No power
	Red	On	Warning message
		Off	Normal

### 8.4 Buzzer

A buzzer is located inside the Data Logger, it will emit a warning tone in case of failure.

## 9. System parameters interface

### 9.1 System parameter

By default, the system will enter the System Parameter Interface, and the LCD will automatically scroll to display the actual time information.

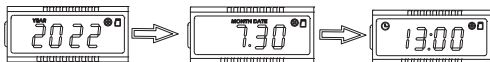

Briefly press the OK key to quickly view all system parameters.

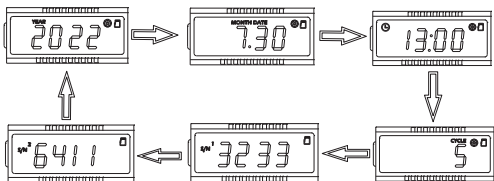

### Parameter setting operation



Indicates the current year, long press the MENU key . Blinking, Briefly press MENU and OK to adjust the year.



Indicates the current date. Long press MENU key  to flash. Briefly press MENU and OK keys to adjust the date.



Indicates the current time. Long press the MENU key  to flash. Briefly press the MENU and OK keys to adjust the current time.

\*At 12:00 (noon), the data logging device is synchronized with the connected solar controller and automatically updated to the actual time.



This indicates that data is stored once every 5 minutes. Long press the MENU key  to adjust the current number of minutes, Can be set between 1~30 minutes.

If data is stored once every minute, a 1GB memory card can store data for 18 years.



Indicates the device ID 1 (i.e. the first four digits of the device ID), and also indicates that the first four digits of the stored internal file name are 3233.



Indicates that the device ID 2 (the last four digits of the device ID) also indicates that the last four digits of the stored internal file name are 6411.

The current ID is consistent with the internal file name of the memory card.

Micro SD/TF card will automatically create a new folder with SN1 and SN2 combined codes to save data. The name of the saved data folder with SN number on the left is 32336411.

The Data Logger automatically stores data in this folder, and automatically creates a CSV file named by month after month for every month, such as 202209.CSV; Usually WORDPAD (see NOTE), or EXCEL can be used to see the contents of stored data as follows: (WORDPAD and EXCEL are registered trademarks of Microsoft Inc.)

Category	Contents
System parameter	Date, time, Sn. No.
PV parameter	PV voltage, current and power
Battery parameters	Battery voltage, current, power and temperature
Load parameters	Load voltage, current and power
Other	Charging capacity of the day
	Discharge capacity of the day
	Accumulated charge
	Accumulated discharge
	Charging periods
	Over times
	Controller internal temperature





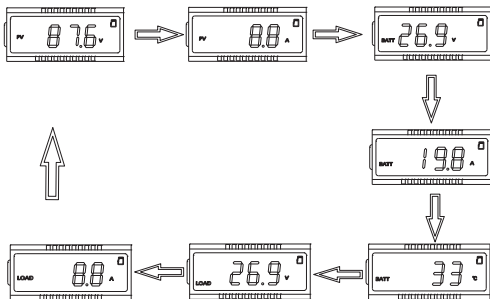





## 9.2 Controller connection status

While in System Parameter Interface, briefly press MENU and long press OK to enter the check status. The LCD scrolls displaying PV, BATT and LOAD parameters. Parameters can also be quickly reviewed by briefly pressing OK.



In Real-Time Interface mode, briefly press MENU again and long press OK to exit the Real-Time Interface modus and enter the System Parameter Interface.

## 10. Fault indication info

Fault	Icon	Fault information description
Short-circuit protection	 E1	Controller in briefly circuit protection alarm, LCD shows E1
Overcurrent Protection	 E2	Controller in overcurrent protection alarm, LCD shows E2
Battery low voltage protection	 E3	Controller in low voltage battery alarm condition and the LCD shows E3
Battery overvoltage protection	 E4	Controller in battery overvoltage protection alarm and the LCD shows E4
Over temperature protection	  E5	Controller in over temperature alarm condition and the LCD shows E5
Communication failure	 E6	D-Log connection controller communication failure, LCD displays E6
The memory card is full or the format used is not supported	 E7	Only FAT16 and FAT32 formats are supported. NTFS format not. In FAT32 format, when memory card is full, LCD shows E7
Memory card failure	 E8	Check the memory card, LCD display shows E8
Button cell battery failure	 E9	Button battery is not installed or battery voltage is too low. LCD indicates E9



# 11. System application recommendation

## 11.1 Basic application

### 11.1.1 Advantages

DLog-1 can monitor the working and fault status of the solar charge controller and store relevant information.

### 11.1.2 System components:

Item	Name	Qty
1	Solar charge controller	1 unit
2	Data Logger	1 unit
3	RS485 communication cable (standard)	1 unit
4	PV panels, battery, DC loads	Select according to the requirements

### 11.1.3 Connection Diagram

- RS485 communication port of DLog-1 is connected to the solar charge controller

- Power cable
- Power cable
- - - RS485 Communication cable

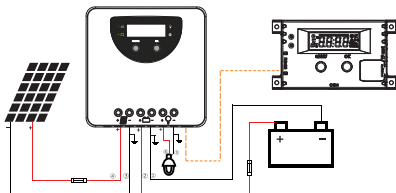

## 11.2 Application solutions upgrading

### 11.2.1 Schematic description

DLog-1 also allows PC software to set parameters and monitor the operating status of the solar charge controller.

### 11.2.2 System components list

Item	Name	Qty
1	Solar charge controller	1 unit
2	Data Logger	1 unit
3	RS485 communication cable (standard)	1 unit
4	PV panels, battery, DC loads	Select according to the requirements
5	PC	1
6	Type-C USB connector data cable	1

### 11.2.3 Connection Diagram

— Power cable

— Power cable

- - - - - Rs485 Communication cable

- RS485 communication port of DLog-1 is connected to the solar charge controller
- PC can set controller parameters and monitor the system operating status

